

Bauart <i>Design</i>	Kolbenbetätigtes Schrägsitzventil <i>Piston-operated angle seat valve</i>
Nennweiten / Nominal sizes	DN 10 - 50
Druckbereich / Pressure range	0 - max. 16 bar
Gehäusewerkstoff / Body material	Edelstahl / <i>Stainless steel</i>
Sitzdichtung / Seat seal	PTFE
Spindeldichtung / Stem seal	PTFE
Temperaturbereich <i>Temperature range</i>	Medium / <i>Media</i> : -10 °C ... +180 °C Umgebung / <i>Ambient</i> : max. +60 °C
Anschluss / Connection	Innengewinde / <i>Internal thread</i> G 3/8" - G 2", Anschweißenden nach DIN EN 10357 (ehem. DIN 11850) und DIN EN ISO 1127 / ISO 4200* ² <i>Welding ends acc. to DIN EN 10357 (former DIN 11850) and DIN EN ISO 1127 / ISO 4200*²</i>
Steuermedium / Control media	Luft / <i>Air</i>
Steuerdruck <i>Control pressure</i>	3 - 7 bar, s. Steuerdruck-Diagramm <i>3 - 7 bar, see control pressure diagram</i>
Vorsteuerung <i>Pilot control</i>	optional mit 3/2-Wege Pilotventil <i>optional with 3/2-way pilot valve</i>
Einbaulage / Installation position	beliebig / <i>in any position</i>
Viskosität / Viscosity	max. 600 mm ² /s

fremdgesteuert, mit Mediumstrom schließend
externally controlled, closing with flow direction

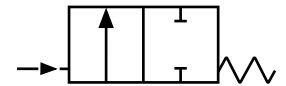

Schaltfunktion: NC (unbetätigt geschlossen)
(NO optional erhältlich)
Switch function: NC (normally closed)
(NO optionally available)



Dichtung <i>Seal</i>	Temperaturbereich <i>Temperature range</i>	Leckrate* ¹ <i>Leakage rate*¹</i>
PTFE	-10 °C ... +180 °C	A
RTFE	-10 °C ... +180 °C	A

*1 nach EN 12266-1 / acc. to EN 12266-1

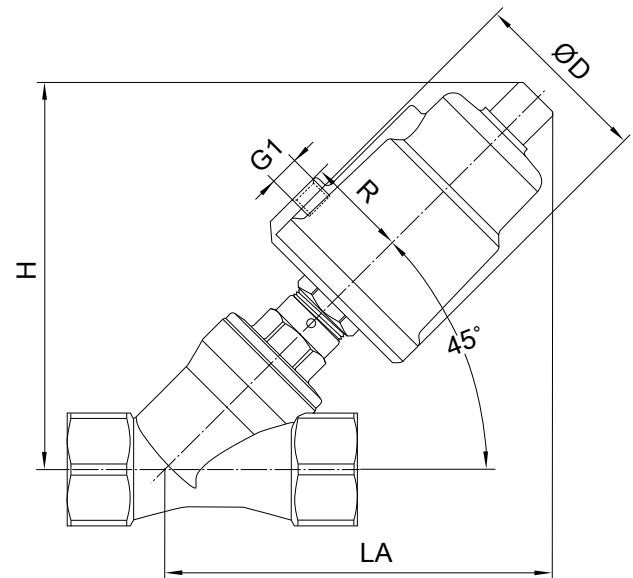

Nennweite <i>Nominal size</i> [mm]	Antriebsgröße <i>Actuator size</i>	Druckbereich <i>Pressure range</i> [bar]	Kv-Wert <i>Kv value</i> [m ³ /h]	H / LA	G1	Ø D	R
10	2 (40 mm)	0 - 16	4,7	109	G 1/8	50,5	27
10	3 (50 mm)	0 - 16	4,7	121	G 1/8	62	34
15	2 (40 mm)	0 - 16	4,7	109	G 1/8	50,5	27
15	3 (50 mm)	0 - 16	4,7	121	G 1/8	62	34
20	3 (50 mm)	0 - 16	9,5	125	G 1/8	62	34
25	3 (50 mm)	0 - 16	18,1	131	G 1/8	62	34
25	4 (63 mm)	0 - 16	18,1	153	G 1/8	77	41,5
32	4 (63 mm)	0 - 16	23,1	161	G 1/8	77	41,5
40	4 (63 mm)	0 - 16	32,9	169	G 1/8	77	41,5
50	4 (63 mm)	0 - 10	52,8	180	G 1/8	77	41,5
50	5 (80 mm)	0 - 16	52,8	195	G 1/4	98	52

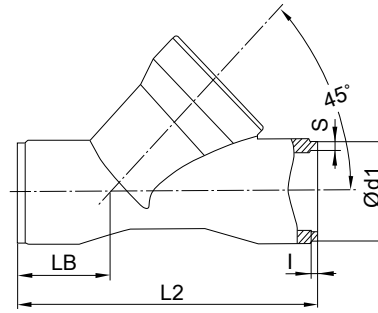
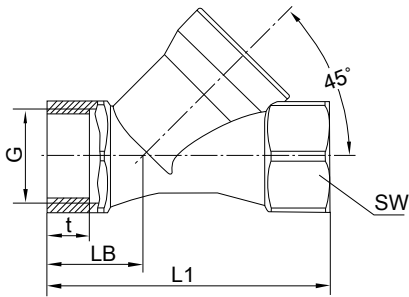

Anschluss - Innengewinde <i>Connection - Internal thread</i>					
DN	L1	LB	SW	G	t
10	74	25,5	22/ 6-kt	3/8"	10
15	74	25,5	25/ 6-kt	1/2"	11,5
20	84	29	31/ 6-kt	3/4"	14
25	100	33,5	39/ 6-kt	1"	15
32	112	36	50/ 8-kt	1 1/4"	18
40	126	41	56/ 8-kt	1 1/2"	18
50	146	46	68/ 8-kt	2"	22

Anschluss - Anschweißenden / <i>Connection - Welding ends</i>														
DN	L2	LB	DIN EN 10357-SA (DIN 11850-R2)			DIN EN 10357-SB (DIN 11850-R1)*2			DIN EN 10357-SC / ISO 1127 / 4200*2			DIN 11850-R3*2		
			l	Ø d1	s	l	Ø d1	s	l	Ø d1	s	l	Ø d1	s
10	70	22	2	13	1,5	2	12	1	2	17,2	1,6	2	14	2
15	88	30	2	19	1,5	2	18	1	2	21,3	1,6	2	20	2
20	92	30	2,5	23	1,5	2,5	22	1	2,5	26,9	1,6	2,5	24	2
25	110	35	3	29	1,5	3	28	1	3	33,7	2	3	30	2
32	126	39	3	35	1,5	3	34	1	3	42,4	2	3	36	2
40	144	46	3	41	1,5	3	40	1	3	48,3	2	3	42	2
50	166	48	3	53	1,5	3	52	1	3	60,3	2	3	54	2

*2 Anschweißenden nach DIN EN 10357-SB oder -SC sowie ISO 1127 / 4200 auf Anfrage
Welding ends according to DIN EN 10357-SB or -SC and ISO 1127 / 4200 on request

Steuerdruck-Diagramme / *Control pressure diagrams*

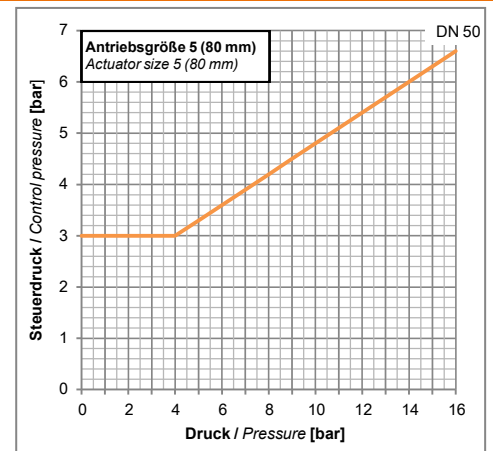
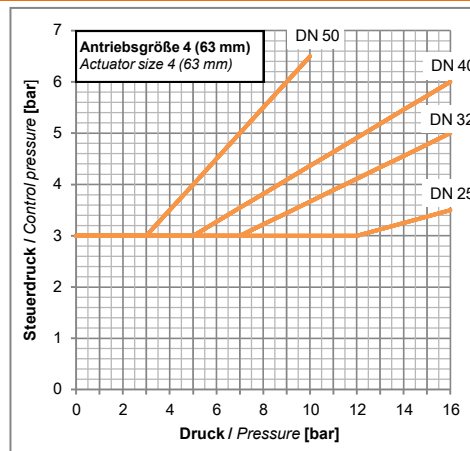
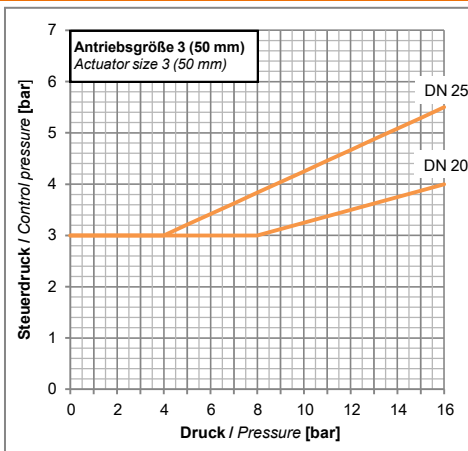

Ventiloptionen / *Valve options*

Schaltfunktion NO (unbetätigt geöffnet)
Switch function NO (normally open)

DN 65 auf Anfrage
DN 65 on request

Antriebsgröße 6 für DN 50 (geringerer Steuerdruck erforderlich)
Actuator size 6 for DN 50 (lower control pressure required)

Geänderte Druckbereiche
Other pressure ranges

Pilotventil: direkt an Schrägsitzventil montierbar / Schlauchsteckverbinder 6mm / mit Handnotbetätigung
Pilot valve: can be mounted directly on the angle seat valve / push-in connector 6mm / with manual override

Mit elektrischer Stellungsrückmeldung
With electrical position indicator